

Article number: 3311F215

Description: Gear Coupling FST215 without bore

Measures

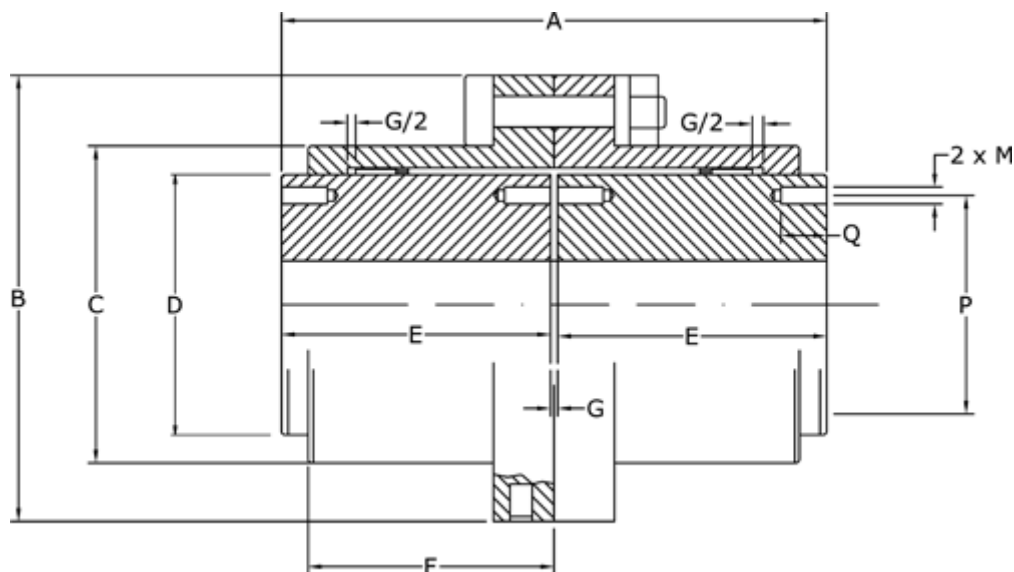

A = 358

B = 405

C = 338

D = 286

E = 175

F = 151.5

G = 8

M = M16

P = 250

Q = 24